

Gasmate®

PHOENIX DROP IN 4 BURNER BBQ

Stainless Steel Model NO. BQ2047, BQ2047NG,
Black Model NO. BQ2047BL, BQ2047BLNG

- Premium #304 grade stainless steel or Matt black finish
- Flame Failure Device (FFD) for added safety
- Electronic ignition
- Satin enamel cast iron hot plate and grill
- Convenient lid gives you extra bench space when not in use
- Stainless steel burners
- Supplied fully assembled
- Gas Certified to Australian Standards
- Suitable for Natural Gas conversion

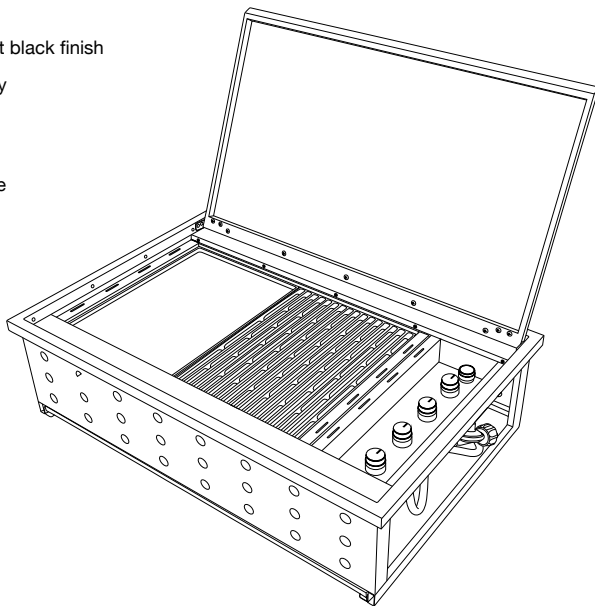

SafeLok®

LCC27 REGULATOR SUPPLIED (LPG OR ULPG MODELS ONLY)

This LCC27 Regulator can only be used with the new safer industry standard LCC27 Gas Cylinder Connection.

FOR OUTDOOR USE ONLY

WARNING:

Improper installation, adjustment, alteration, service or maintenance can cause injury or property damage.

Read the instructions thoroughly before installing or servicing this equipment.

WARNING! DO NOT USE AN ADAPTOR ON THE CYLINDER CONNECTION

FOR YOUR SAFETY

If you smell gas:

1. Shut off the gas to the appliance.
2. Extinguish any open flame.
3. If odour continues, immediately call your gas supplier.

Do not store or use gasoline or other flammable vapour and liquids in the vicinity of this or any other appliance.

Important: Retain these instructions for future use.

GENERAL INFORMATION



IMPORTANT

Read these instructions carefully prior to use. Familiarise yourself with the appliance before connecting it to its gas container. Keep these instructions for future reference.



If you smell gas

1. Shut off gas to the barbecue at its source, if possible.
2. Extinguish any open flame.
3. Open hood.
4. If odour continues immediately call your gas supplier or fire department.

Gas Installation Codes

- Barbecues must be used in accordance with the installation requirements of your gas supply authority, or the Australian Standard AS 5601.
- Barbecues for use with bottled gas are labelled 'propane gas'.
- Barbecues for use with natural gas are labelled 'natural gas' and must be installed by an authorised person. Check the gas type sticker attached to the barbecue.

Clearances

Minimum Clearances from combustible materials must be: Rear - 100mm, Sides - 100mm, Above - 1000mm

Hose & Regulator Safety

Propane Model - The regulator and hose assembly supplied with the 'Propane Gas' or 'Universal L.P.G.' barbecues are suitable for propane gas only. A gas regulator adjusted to have an outlet pressure of 2.75kPA is supplied for connection to the propane gas cylinder. The pressure regulator and hose assembly supplied with the barbecue must be used. Replacement pressure regulators and hose assemblies must be those specified by the barbecue manufacturer.

When connecting the hose and regulator assembly to the gas cylinder, take care to avoid unnecessary twisting or kinking of the flexible hose.

After the assembly has been secured, turn on the gas and check for leaks by brushing a soap and water solution over all connections.

If you are unable to correct the leak by tightening the connections, turn off the gas and contact the supplier immediately.

Always ensure the barbecue is kept away from flammable

materials and the gas cylinder clear of any heat source. When changing over from an empty gas cylinder to a full one make sure this procedure is carried out in a well ventilated location, preferably outside, away from people and away from any sources of ignition; such as naked flames, pilot flames, electric heaters/equipment.

Specifications

Barbecue specifications can be found on the data label attached to the barbecue body. Hose connection thread at gas inlet is 5/8"-18 UNF.

Gas Cylinder Use & Safety

This is a low pressure barbecue and must only be used with the hose and regulator supplied. Your barbecue is designed for use with 9Kg propane gas cylinders certified to AS 2469.

The cylinder should be filled by a reputable gas supplier and visually inspected and re-qualified at each filling.

Always keep cylinder in an upright position. Always close the cylinder valve when the barbecue is not in use.

Do not subject the cylinder to excessive heat.

Never Store your Gas Cylinder Indoors.

If you store your barbecue indoors, ALWAYS disconnect the cylinder first and store it safely outside. Cylinders must be stored outdoors in a well ventilated area out of reach of children, and must not be stored in a building, garage or any other enclosed area.

Location of your Barbecue

DO NOT use your barbecue in garages, porches, sheds, breezeways, or other enclosed areas. Your barbecue is to be used OUTDOORS. The barbecue is not intended to be installed in or on recreational vehicles and/or boats and should not be placed under any surface that will burn. Do not obstruct the flow of combustion and ventilation air around the barbecue housing.

Check Barbecue for any Damage

Inspect barbecue parts as you proceed. Contact your supplier for assistance regarding replacement of any damaged or missing parts. Do not assemble or operate a barbecue that appears damaged. Barbecues for use with gas cylinders are labelled 'Propane Gas' or 'Universal L.P.G.'. Check labelling at the gas connection on your barbecue.

Protect Children

Keep children away from barbecue during use and until barbecue has cooled after you have finished. Do not allow children to operate barbecue.

Always ensure that no sporting or physical activities are carried out in close proximity to the barbecue during use and while still hot.



WARNING

Failure to comply with these instructions could result in a fire or explosion which could cause serious bodily injury, death or property damage.

CAUTION: Accessible parts may be very hot.

- Keep young children away.
 - DO NOT modify this barbecue.
 - Do not move this barbecue during use.
 - Turn off gas supply at the cylinder after use.
 - Read instructions before using the barbecue.
 - Parts sealed by the manufacturer or their agent must not be manipulated by the user.
 - This barbecue is only to be used and stored outdoors.
 - Never operate this barbecue without a regulator
 - Do not test for gas leaks with an open flame
 - If this information is not followed exactly, a fire causing death or serious injury may occur. Do not store a spare gas cylinder under or near this barbecue. Never fill the cylinder beyond 80% full. This barbecue is only to be used and stored outdoors.
 - If there is a leak on your appliance (smell of gas immediately attempt to turn off the cylinder valve. Remove the appliance to a well ventilated location away from any ignition source. Only check for leaks outdoors using soapy water. DO NOT try to detect leaks using a flame.
 - Check for leaks by brushing a soap and water solution over all connections. If you are unable to correct the leak by tightening the connections, turn off the gas and contact customer service immediately.
 - Only use the hose assembly as supplied with this appliance for connection to the cylinder - DO NOT USE ADAPTORS.
 - After use turn the gas cylinder valve off, wait for the flame to go out, then turn the appliance control valve off.
 - Do not connect your barbecue to a gas cylinder exceeding 9kg capacity.
 - Never connect an unregulated gas cylinder to your barbecue.
 - Read carefully before assembling and operating your barbecue.
- ### FOR YOUR SAFETY
- Do not spray aerosols in the vicinity of this appliance while it is in operation.
 - Do not use or store flammable materials in or near this appliance
 - Do not place articles on or against this Appliance
 - Do not modify this appliance. Avoid twisting or kinking the flexible hose.
 - Do not store or use petrol or other flammable liquids in the vicinity of this or any other appliance.
 - Do not store empty or full spare gas cylinders under or near this or any other appliance.
 - Never test for gas leaks with a lit match or open flame. Never light barbecue with hood closed or

before checking to ensure the burner tubes are fully seated over gas valve orifices.

- Never lean over cooking surface when lighting.
- Never alter or modify the regulator or gas supply assembly.
- Ensure the barbecue is set up on a level and stable surface.
- Do not move the barbecue while in use or when hot.
- Remove the drip tray before moving.
- The built-in barbecue cannot be installed with an overhead combustible surface.
- The built-in barbecue can only be installed with an overhead surface or grease filter with a minimum of 1200mm vertical clearance.
- This barbecue must not be used indoors.
- Only use in well ventilated areas.
- CARBON MONOXIDE HAZARD - USING THIS APPLIANCE IN AN ENCLOSED SPACE MAY CAUSE DEATH. DO NOT USE IN CARAVANS, TENTS, MARINE CRAFT, CARS, MOBILE HOMES OR SIMILAR LOCATIONS.
- DO NOT install in, or connect to the consumer piping or gas supply system of a boat or caravan.
- This appliance shall only be used in an above ground open-air situation with natural ventilation, without stagnant areas, where gas leakage and products of combustion are rapidly dispersed by wind and natural convection.
- Ensure the barbecue is set up on a level and stable surface.
- Do not move the barbecue while in use or when hot. Remove the drip tray before moving.
- DO NOT replace the grill with an extra hotplate. The warranty will be voided and it violates the gas approval, the grill provides the ventilation needed for the BBQ to operate safely. It is not designed to be a solid hotplate device.

IF THERE IS A LEAK

- Turn the cylinder off.
- Ventilate the area to disperse gas.
- Check all connections.
- If leak persists, keep the cylinder upright. Keep skin away from any gas or liquid escaping from the cylinder.
- Keep the cylinder at least 20 metres away from any sparks or ignition sources, including electrical equipment, camera flashes, engines and motors.
- Disperse gas by encouraging maximum ventilation and spraying with a fine water spray.

IF THERE IS A FIRE

- If the fire is at the barbecue, turn the gas off at the cylinder. Smother the flames with a wet cloth, fire blanket or extinguish using a fire extinguisher.
- If the fire is at the cylinder, or you can not get to the valve to turn the gas off, contact the fire brigade immediately.
- Using a garden hose, direct the water to the middle of the cylinder to keep it cool. Try not to extinguish the flame. At least if the gas is burning, it won't be able to build up pressure and explode.

GENERAL ASSEMBLY

Connecting & Disconnecting to the Gas Source

Familiarise yourself with the general information and safety guidelines located at the front of this manual.

DO NOT USE AN ADAPTOR ON THE CYLINDER CONNECTION

Check

1. The cylinder is filled. A sloshing sound will be heard when shaken.
2. The burner controls are in the 'OFF' position

Connecting

1. Ensure cylinder valve is in its full off position.
2. Check for any damage to either the cylinder connection or the hose. NEVER attempt to use damaged equipment.
3. When connecting the hose to the cylinder tighten the nut to a positive stop by hand.
4. Open cylinder valve fully. If a leak can be heard at either end of the hose turn cylinder off and tighten joint. Wait 5 minutes before re-testing and use a soapy water solution to check the joint. If bubbles appear the connection will need to be re-tightened.

1. Ensure the burner control is in the 'OFF' position.
2. Ensure cylinder valve is in the full off position.

For storage and cylinder exchange, disconnect hose at the cylinder only, DO NOT disconnect hose from appliance.

Disconnecting

1. Ensure the burner control is in the 'OFF' position.
2. Ensure cylinder valve is in the full off position.

FOR STORAGE AND CYLINDER EXCHANGE, DISCONNECT HOSE AT THE CYLINDER ONLY, DO NOT DISCONNECT HOSE FROM APPLIANCE.

REMOVE TRANSIT PACKAGING MATERIAL BEFORE USE.



IMPORTANT

- Do not smoke when attempting to ignite the barbecue.
- Never use volcanic rock, heat beads or other material.
- Always use protective gloves when handling hot components.
- Note: If for some reason, ignitor fails to produce a spark at the electrode, barbecue can be lit by a long barbecue match. With the cover removed, lift out the grill plate and light a burner with a match or lighter. Subsequent burners will crosslight.
- The lid must be in the open position for lighting and during use.
- Do not leave the barbecue unattended when alight.
- Clean your barbecue after each USE. DO NOT use abrasive or flammable cleaners, as it will damage the parts of the product and may start a fire. Clean in warm soapy water.
- IMPORTANT: Before connecting and disconnecting barbecue to gas source, make sure burner controls are in 'OFF' position.
- CAUTION: When the barbecue is not in use, the gas must be turned off at the cylinder
- Check that the seals between the appliance and the gas cylinder are in place and in good condition before connecting the gas cylinder
- Do not use this appliance if it has damaged or worn seals.
- Check performance of burner prior to installing BBQ plates.

LIGHTING PROCEDURE

Install and replace battery (4 Burner BBQ)

The BBQ is featured with electronic ignitions system, which is powered by one AA battery.

To install or replace a battery, rotate to remove the battery cover. Insert a new battery as below image shows, then replace the battery cover.

NOTE: Ensure the battery has been placed in the correct orientation as shown.

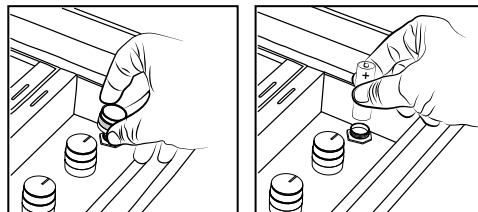

Burner Operation & Ignition System Check

1. Open the Lid of the barbecue before attempting to light the burners.
2. Turn the control knobs clockwise to "OFF" position.
3. Connect the regulator to the gas bottle. Turn the gas supply "ON" at the cylinder. Check with the use of soapy water for any gas leakage between the bottle and the regulator.
4. Push down a control knob and keep pressing whilst turning anti-clockwise to the "HIGH" position (a clicking sound is heard). Continue to hold the control knob for 10 seconds (This is to ensure the Flame Failure Device to be engaged). Release then check the flame stays on.
5. If the burner still does not light, turn the control knob to 'OFF' wait 5 minutes and repeat the lighting procedure.
6. Adjust the heat by turning the knob to the High/Low position.
7. To turn the barbecue 'OFF', turn the cylinder valve to the 'OFF' position and then turn all of the control knobs on the appliance clockwise to the 'OFF' position.

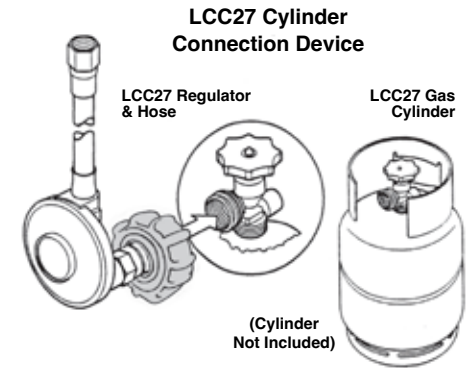

Problem	Possible Reason	Solution
Burner will not ignite	Valve on cylinder is closed	Open valve on cylinder
	Control knob is off	Turn knob to high when lighting
	Ignition system not working	Check battery - The control knob should have a clicking sound when pressed
	Burner has gone out	Check that the gas bottle is not empty
	Igniter is faulty	Use a long barbecue match
Flame not staying on once control knob is released	Control knob not held down long enough for Flame Failure Device to engage	Repeat the lighting procedure and hold control knob down for 15 seconds

Nominal Hourly Gas Consumption

Model No.	Gas Type	Number of Burners	Injector Size	Total Gas Consumption MJ/h	Gas Pressure kPa
BQ2047 BQ2047BL	ULPG	4	Ø 1.05mm	54 MJ/h	2.75 kPa
		MJ/h Each	13.5 MJ/h		
BQ2047NG BQ2047BLNG	Natural Gas	4	Ø 1.80mm	54 MJ/h	1.0 kPa
		MJ/h Each	13.5 MJ/h		
S.G.A. Pty Ltd. 33-35 Lionel Road, Mt. Waverley, Victoria 3149, Australia. FOR CORRECT OPERATION REFER TO INSTRUCTIONS PROVIDED.				A.G.A Approval No.	AGA 9058 G AGA 9117 G

CARE & MAINTENANCE

Location of your Barbecue

DO NOT use your barbecue in garages, porches, sheds, breezeways, or other enclosed areas. Your barbecue is to be used OUTDOORS. The barbecue is not intended to be installed in or on recreational vehicles and/or boats and should not be placed under any surface that will burn. Do not obstruct the flow of combustion and ventilation air around the barbecue housing.

Protect Children

Keep children away from barbecue during use and until barbecue has cooled after you have finished. Do not allow children to operate barbecue.

Always ensure that no sporting or physical activities are carried out in close proximity to the barbecue during use and while still hot.

Tools You Will Need

Adjustable spanner, Phillips head screwdriver.

Check Barbecue for any Damage

Inspect barbecue parts as you proceed. Contact your supplier for assistance regarding replacement of any damaged or missing parts. Do not assemble or operate a barbecue that appears damaged. Barbecues for use with gas cylinders are labelled 'Propane Gas' or 'Universal L.P.G.'. Check labelling at the gas connection on your barbecue.

As with all appliances, proper care and maintenance will keep them in top operating condition and prolong their life. Your new gas barbecue is no exception. By following these cleaning procedures on a timely basis, your barbecue will be kept clean and working properly with minimum effort.

Cleaning the Cooking Surface

After cooking, turn burner control to 'OFF' and let barbecue cool before attempting to clean the cooking surface. Before first use and periodically, it is suggested that you wash the cooking surface in a mild soap and warm water solution.

Care of Cooking Surface

Use and care of the cooking surface is important. Do not use pans on the cooking surface. Do not overheat the cooking surface with the hood down or no food on the cooking surface.

Cleaning the Drip Tray

To avoid fat or grease dripping from the barbecue remove and empty the drip tray after each use. Wait until the drip tray is cool to touch before disposing of contents.

The drip tray should be washed periodically in a mild detergent and warm water solution.

General Cleaning of Painted Surface

When cleaning your BBQ use a mild dish soap combined with warm water and a microfiber cloth to clean the surface. Then rinse your BBQ with clean water.

Note: Never use steel wool or any hard cleaning pad on any painted and stainless steel surface, as it can cause surface damage.

If not in use, turn off the gas from the source. After cleaning and when it is dry, spray some canola oil over the whole BBQ surface and wipe off the excess with microfiber cloth to enhance the surface protection. Then cover the BBQ with a BBQ cover and store it in a dry place.

CARE AND CLEANING OF STAINLESS STEEL

Stainless steel parts of this appliance are made from 304 & 430 grade stainless steel. To preserve the appearance and corrosion resistance of the stainless steel material regular cleaning is required. Although stainless steel does not rust in the same manner as steel it can still exhibit 'corrosion' blemishes that look similar to rust and detract from the appliances appearance. Unlike steel, the corrosion of stainless steel is mostly confined to the surface and in most cases can be removed by cleaning, returning the surface to almost like new.

The most common form of corrosion that affects stainless steel is what is known as 'Tea Staining'. This shows up as brown spots on the surface, hence the confusion with rusting. This is most common in coastal areas but depending on the environment can also occur in inland areas. If the 'Tea Staining' marks are not regularly cleaned from the material surface they can penetrate into the material and become very difficult to remove, the application of a metal polish would then be required.

If the appliance is located near swimming pools careful attention to cleaning is required. Pool chemicals contain chlorides which can affect the stainless steel. This also applies to salt water pools as they contain salt, namely sodium chloride.

The use of bleaches containing chlorine should not be used to clean the stainless steel surfaces. If the residues are not completely rinsed away they can cause heavy pitting of the material. Pitting corrosion eats deep into the surface and is not easily removed. Heavy polishing is required.

ROUTINE CARE

After each use allow the appliance to cool then wipe over with a soft, damp, soapy cloth. (DO NOT USE CLEANERS CONTAINING CHLORIDE). Finally wipe over with soft, damp cloth. Be sure to wipe off food particles and cooking residues, some marinates and oils can be acid and therefore attack the metal surface. Also, cooking residues that are not removed after each use bake into the surfaces during subsequent uses and become more difficult to remove.

There are a number of proprietary stainless steel cleaners available that can be safely used on this appliance. Read the directions carefully before using

DO NOT USE STEEL WOOL as particles can become embedded in the surface and then rust resulting in small brown specs on the surface. If scouring is required to remove stubborn cooking residues use a soft nylon pad (non-abrasive).

DO NOT USE ABRASIVE CLEANING COMPOUNDS, use cream type. If the appliance is used on an irregular basis it is advised to still clean regularly and keep it covered from the elements, either by using a purpose BBQ cover or under a covered porch. Dirt and dust contain corrosive particles from the environment that can attack the surface. Stainless steel surfaces retain their best resistance to corrosion when kept clean. Even if the appliance is protected with a purpose BBQ cover check regularly, condensation underneath the cover may be corrosive due to the local environment and cause damage to the metal surface.

After cleaning applying a thin coating of 'light oil', for example baby oil, will also help protect the stainless steel surface from the elements.

Stubborn Stains and Corrosion Spots

Stubborn stains, discolouration, 'Tea Staining' can occur from insufficient cleaning, excessive spillage from cooking, severe environmental conditions and extreme cooking conditions.

There are propriety stainless steel cleaners available that are designed for such instances. Read the instructions carefully before using.

- Always rub or wipe in the direction of the surface grain or original polish lines.
- Some stainless steel cleaners may damage painted or plastic surfaces, read the directions carefully.

Flash-Back

Spiders and small insects occasionally spin webs or make nests in the burner tubes during warehousing and transit. These webs can lead to a gas flow obstruction which could result in a fire in and around the burner tubes. Cleaning with a soft brush before use and at least every six months is recommended.

This type of fire is known as 'FLASH-BACK' and can cause serious damage to your barbecue and create an unsafe operating condition for the user. Although an obstructed burner tube is not the only cause of 'FLASH-BACK' it is the most common cause and frequent inspection and cleaning of the burner tubes is necessary.

If fire occurs in and around the burner, immediately turn off gas at its source and turn the burner control to 'OFF', wait until the barbecue has cooled, then clean the burner tubes and burner ports.

CLEANING THE BURNER

Follow these instructions to clean and/or replace burners.

1. Turn gas off at control knobs and gas cylinder.
2. Remove cooking grates and grease tray.
3. Remove clip at end of burner.
4. Carefully lift each burner up and away from valve openings.

CAUTION: Inspect burner for any damage (cracks or holes). If damage is found, replace with a new burner. Reinstall the burner, check to ensure that the gas valve orifices are correctly positioned and secured inside the burner inlet.

We suggest three ways to clean the burner tubes. Use the one easiest for you.

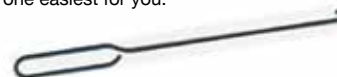

- (A) Bend a stiff wire (a light weight coat hanger works well) into a small hook. Run the hook through each burner tube several times.
 - (B) Use a narrow bottle brush with a flexible handle (DO NOT use a brass wire brush), run the brush through each burner tube several times.
 - (C) Wear eye protection: use an air hose to force air into the burner tube and out the air ports. Check each port to make sure air comes out each hole.
5. Wire brush entire outer surface of burner to remove food residue and dirt.

6. Clean any blocked ports with a stiff wire such as an open paper clip.
7. Check burner for damage, due to normal wear and corrosion some holes may become enlarged. If any large cracks or holes are found replace burner.
8. Carefully refit burners, ensuring they are located on the gas valve.
9. Replace clip at the end of burner.
10. Replace grease tray and cooking grates.



WARNING

Beware of spiders and wasps. Burner tube should be inspected and cleaned periodically.

To avoid any flare-ups, it is recommended that the drip tray be checked and emptied regularly. Contents of the drip tray may be very hot during cooking. If emptied during extended cooking extreme caution should be taken and direct contact by hand should be avoided at all times. Allow to cool completely before disposing of the contents.

Should the burners extinguish for any reason, turn off all control knobs and the cylinder gas valve. Wait 5 minutes before attempting to relight the appliance.

If a grease or fat fire occurs, turn off all control knobs and gas cylinder valve immediately until the fire is out.

A leak test must be carried out prior to using the appliance for the first time or each time the gas cylinder is refilled or each time the gas hose and gas regulator being disconnected from the gas cylinders or appliance.

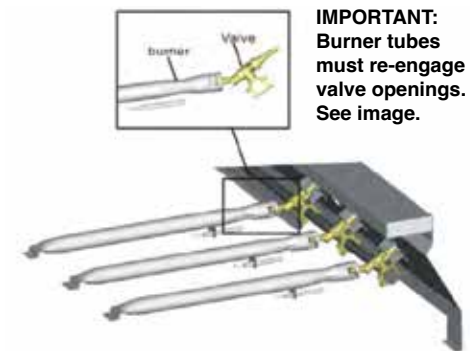

PRODUCT DIMENSIONS

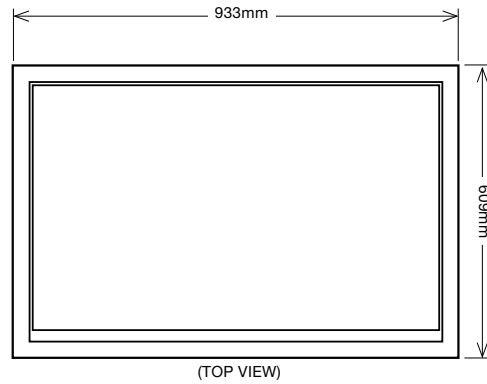
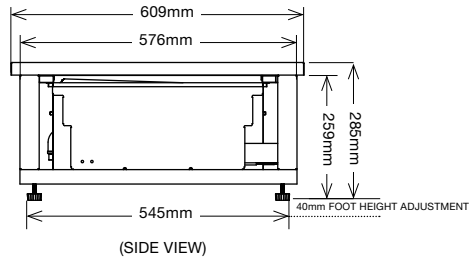
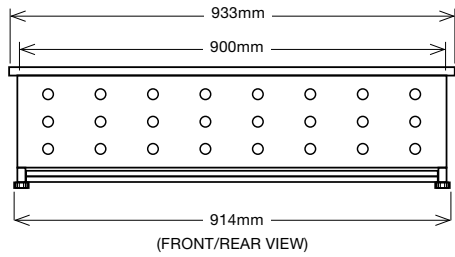

WARNING

This drop-in BBQ is designed to sit flush with the bench. However, if you choose to install the BBQ on top of the stone bench, you need to make sure the legs are supporting the BBQ.

The appliance requires venting. When the BBQ is sitting flush with the bench, there is an approximate 2mm gap around the BBQ edge with the bench. This gap plays an important role of venting, therefore, it should not be sealed with silicon. If you choose, however, to seal the gap, a rectangular unimpeded opening of approx 750mm W x 10mm H in either the front or the rear should be incorporated within the cabinet. Please refer to diagram below as an example.

BENCH CUT-OUT DIMENSIONS

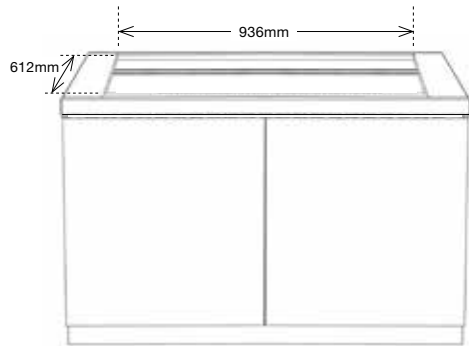

The cutout size, when sitting the BBQ flush with the stone bench

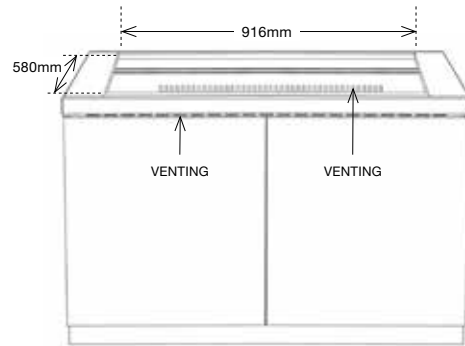

The cutout size, when sitting the BBQ on top of the stone bench

Feet Adjustment:

4 adjustable feet are supplied with the BBQ. Please ensure all 4 feet are attached to the BBQ for height adjustment. If you plan to install the drop in BBQ in our Alfresco Plus BBQ cabinet module, please adjust the feet of the BBQ so that overall height is 290mm. Adjust the feet of the BBQ so all edges sit flush. If you choose to build your own cabinet, please adjust the feet height accordingly.

Drip tray access:

Please note that you must allow access under the BBQ for the drip tray to be removed.

UNDER BENCH CLEARANCE:
150mm ALL AROUND SIDE WALLS OF BBQ

SPACER BRACKETS

Two spacer brackets have been provided. They are essentially for customers who mount their BBQ into a different type of cavity / cabinetry, where (unlike the AlfrescoPlus BBQ module designed for the BBQ) there are no doors covering the front face of the BBQ - but just a cut out to access the drip tray (880mm x 50mm).

In that set-up, the drip tray could protrude out from the BBQ but aligns up with the cabinet front. Those brackets essentially just push forward the drip tray, for that type of set-up / cabinetry.

BENCH CUT-OUT DIMENSIONS

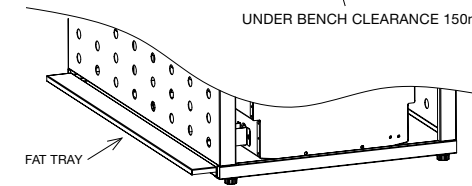
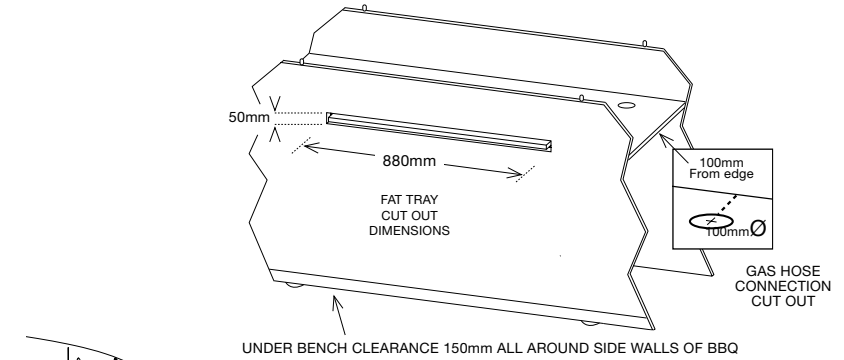

2 x Drip Tray Spacer Brackets (Left & Right Side)

SPACER BRACKET INSTALLATION

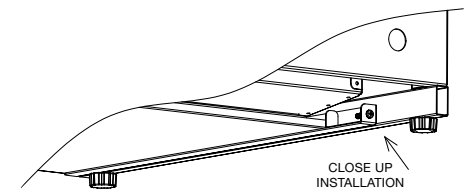
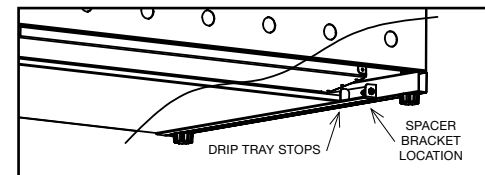
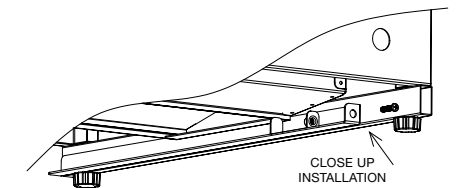
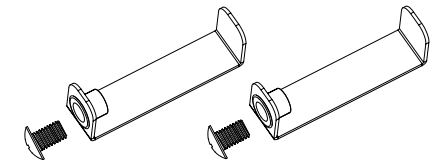
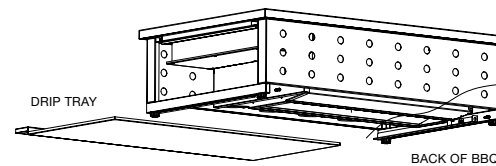

NATURAL GAS CONVERSION



Conversion ONLY to be done by an authorised

TO BE INSTALLED ONLY ON OR IN A NON-COMBUSTIBLE ENCLOSURE

Note: Recommended clearances must be maintained.

GAS PIPING

1. This appliance is only to be installed by an authorised person.
2. Check with local and state plumbing and heating codes regarding sizing of the gas lines.
3. All gas pipe connections must be sealed with a gas pipe compound resistant to Natural Gas.
4. Installation of a drip leg if required in the gas supply line must conform to AS5601.
5. When checking for gas leaks, do not use an open flame. Use a soap and water solution and check for bubbles indicating gas leakage.
6. Installation of 1/8" NPT plugged tapping, accessible for test gauge connections, is required upstream of the gas supply connection.

WARNING

Improper installation, adjustment, alteration, service or maintenance can cause injury or property damage. Read the instructions thoroughly before installing or servicing this equipment.

Overall Dimensions

	Length	Width	Height
BQ2047	933mm	609mm	265mm
BQ2047BL			
BQ2047NG			
BQ2047BLNG			

SERVICING INSTRUCTIONS

Appliances should be serviced at least annually and servicing must only be carried out by a Licensed Plumber or Authorised Person.

Clean the Burner Ports and top with a Soft Brush. Inspect and clean all combustion air inlets, then replace the Burner ensuring it is firmly secured.

Minimum Clearance for Ventilation:

Rear - 50mm Side - 50mm

NOTE TO THE INSTALLER:

Note: For natural gas conversion, you need to purchase the special Natural Gas Valve with built-in Flame Failure Device (FFD) from your supplier.

Similarly, to convert a natural gas version of the BBQ to LPG, you need purchase the special LPG valve with built-in FFD from your supplier for the conversion.

TEST OPERATION OF APPLIANCE BEFORE LEAVING.

PROVIDE A CERTIFICATE OF COMPLIANCE.



WARNING

- Improper installation, adjustment, alteration, service or maintenance can cause injury or property damage.
- Read the instructions thoroughly before installing or servicing this equipment.
- THIS APPLIANCE MUST NOT BE INSTALLED OR USED INDOORS.
- NATURAL GAS APPLIANCE. TO BE INSTALLED ONLY BY AN AUTHORISED PERSON.
- THE AUTHORISED PERSON WILL PROVIDE A CERTIFICATE OF COMPLIANCE.
- An AGA approved high flow natural gas regulator must be installed in the pipeline and be set at 1kPa.

NOTE: BBQ MUST BE TESTED. AND PRESSURE MUST BE 1KPA WITH ALL BURNERS RUNNING

SAFE APPLIANCE LOCATIONS

This appliance shall only be used in an above ground open-air situation with natural ventilation, without stagnant areas, where gas leakage and products of combustion are rapidly dispersed by wind and natural convection.

Any enclosure in which the appliance is used shall comply with the following:

An enclosure with walls on all sides, but at least one permanent opening at ground level and no overhead cover (see Example 1).

Within a partial enclosure that includes an overhead cover and no more than two walls (see Example 2 & 3).

Within a partial enclosure that includes an overhead cover and more than two walls, the following will apply: at least 25% of the total wall area is completely open, and at least 30% of the remaining wall area is open and unrestricted (see Example 4 & 5).

In the case of balconies, at least 20% of the total wall area shall be and remain open and unrestricted.

DIAGRAMMATIC REPRESENTATIONS OF OUTDOOR AREAS

The following figures are diagrammatic representations of outdoor areas. Rectangular areas have been used in these figures – the same principles apply to any other shaped area.

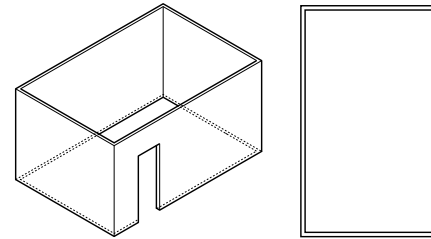

Outdoor Area - Example 1

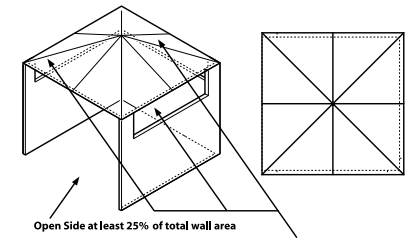

Open Side at least 25% of total wall area
30% or more in total of the remaining wall area is open and unrestricted
Outdoor Area - Example 4

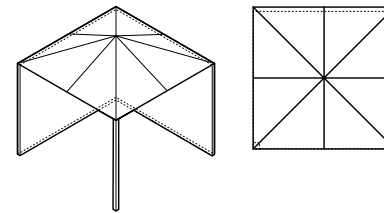

Outdoor Area - Example 2

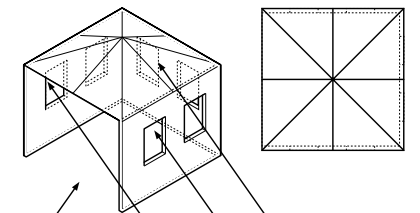

Open Side at least 25% of total wall area
30% or more in total of the remaining wall area is open and unrestricted
Outdoor Area - Example 5

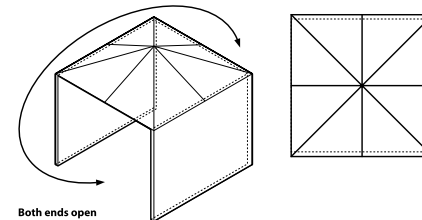

Both ends open

Outdoor Area - Example 3

For any queries or assistance call



Customer Service
(Australia Only)

1300 174 876

Hours of operation:
Monday to Friday 8am - 5pm EST

Do not return to place of purchase.

Keep your purchase receipt, this will be required to
make any claims under the 5 year warranty.

Before any work/modification is done on/to this
product please refer to the link to the SDS for
your personal protection requirements.

<https://sitro.com.au/support/sds/>

Gasmate®