

# Gasmate®

## PORTOFINO 16" GAS PIZZA OVEN

Model No. P03106-16



- Powerful 28.8 MJ/h cast iron burner
- Electronic Ignition
- Durable powder coated body
- Stainless steel inner layer for better heat retaining and durability.
- Stainless steel folding legs
- Generous cooking space
- Includes LCC27 Safe Lok regulator and hose
- Gas certified to Australian Standards

**⚠ OUTDOOR USE ONLY**

**SafeLok®**

**LCC27 REGULATOR SUPPLIED**

This LCC27 Regulator can only be used with the new safer industry standard LCC27 Gas Cylinder Connection.

**Important: Retain these instructions for future use.**

# SAFETY INSTRUCTIONS

## IMPORTANT SAFETY INFORMATION & WARNINGS

### WARNING

- DO NOT SPRAY AEROSOLS IN THE VICINITY OF THIS APPLIANCE WHILE IT IS IN OPERATION. DO NOT USE OR STORE FLAMMABLE MATERIALS IN OR NEAR THIS APPLIANCE
- DO NOT PLACE ARTICLES ON OR AGAINST THIS APPLIANCE
- DO NOT MODIFY THIS APPLIANCE
- FOR OUTDOOR USE ONLY

**IMPORTANT!** Do not attempt to assemble and use this pizza oven unless you have read this entire user manual and have familiarised yourself with all steps and requirements thoroughly. Please keep this manual in a handy place as it has answers for questions that may arise during your future use.

### DANGER

If you smell gas:

- Shut gas off to the appliance
- Extinguish any open flame
- Ensure the appliance door remains open and with clear ventilation
- If odour continues, keep away from the appliance and immediately call your fire department
- Failure to follow these instructions could result in a fire or explosion which could cause property damage, personal injury or death.

### DANGER

- This instruction manual contains important information necessary for the proper assembly and safe use of the appliance
- Read and follow all warnings and instructions before assembling and using the appliance
- Follow all warnings and instructions when using the appliance
- Keep this manual for future reference
- Never operate this appliance in enclosed areas
- Never operate this appliance unattended
- Never operate this appliance within 1.5m of any structure or combustible material and at least 3m away from objects that may spark or ignite gas (i.e. other gas cylinders, live electrical appliances, pilot lights of gas water heaters, etc)
- Never operate this appliance within 7.5m of any flammable liquid
- Heated liquids remain at scalding temperatures long after the cooking process has finished. Never touch the cooking appliance until all elements have cooled to 45°C or less.
- If a fire should occur, keep away from the appliance and immediately call your fire department. Do not attempt to extinguish an oil or a grease fire with water.
- Some parts of this appliance may have sharp edges- wear suitable protective gloves if necessary for handling.
- Never use the protective cover/carry bag unless the appliance has completely cooled.
- Never move the appliance during use or once operating.
- Accessible parts may be very hot during operation- always keep children away during and after use.
- Always ensure that the gas supply is returned to the off position at the gas cylinder after use.
- Do not modify the appliance or its connections in any way- this may be dangerous.
- Ensure the surface you are operating the appliance on is not flammable and suitably protected.

- This appliance is only intended to be used with LPG gas. Do not use lava rocks, briquets, charcoal or other fuel sources.
- Never light the burner with the appliance opening/door covered. Non-ignited gas accumulated inside the closed appliance may cause an explosion.
- Regularly check the appliance during operation to ensure that the burner flames remain ignited.
- Always turn off the gas supply when the appliance is not in use.
- Always turn off the gas supply at the gas cylinder and detach from the appliance before moving. Never move the appliance with the gas supply connected as this can damage your appliance or connection.

### RISK OF FIRE

Most fires are caused by a build up of grease, or an improper gas connection. Ensure all people and pets are kept as far away as possible.

If you are able, turn the gas off at the cylinder or the on/off valve where applicable. Use a fire extinguisher if possible. If water is the only fire retardant available, thoroughly soak the area around the appliance. When spraying water on the Pizza Oven itself, do not use a strong jet of water, as this may cause splashing of burning grease, resulting in a further spreading of the fire.

**IMPORTANT!** Regularly clean your appliance between uses to ensure that residual food or grease won't lead to a fire. Recommend to clean after every use. Damage to the appliance can occur where the appliance is not cleaned regularly.

**CAUTION!** Do not use water to extinguish a grease fire as it may cause an injury. Immediately turn the gas cylinder to the off position as well as the appliance knob to the off position, in the event of a grease fire.

It is difficult to know if your device is producing Carbon Monoxide as it is an odourless and colourless gas. It can, however cause these symptoms when you are exposed to it:

- Tightness across the forehead  
Headache, Weakness, Dizziness, Nausea, Vomiting, Coma, intermittent convulsions, Depressed heart action, slowed respiration.

**WARNING!** Contact your local municipality for any building codes regulating the installation of outdoor barbecue appliances. Outdoor installations must conform to Australian Standards Code AS: 5601 as well as the requirements of any local council, gas electricity authority or other statutory regulation.

Do not modify the appliance. Parts sealed by the manufacturer or the company shall not be manipulated.

### CARBON MONOXIDE

Carbon Monoxide is a highly poisonous gas which can be produced when the device isn't receiving enough ventilation. We therefore recommend using the gas pizza oven in a well ventilated area away from direct wind and to never cover the oven mouth.

**IF THE EXPOSURE HAS BEEN SEVERE IT MAY CAUSE DEATH.**

# PARTIAL ENCLOSURES

## INSTALLATION POSITIONING

The appliance shall only be used in an above ground, open air situation with natural ventilation, without stagnant areas, where gas leakage and products of combustion are rapidly dispersed by wind and natural convection.

### WARNING

- Do not use the gas pizza oven in enclosed or on small balconies.
- Any enclosure in which the appliance is used shall comply with one of the following:

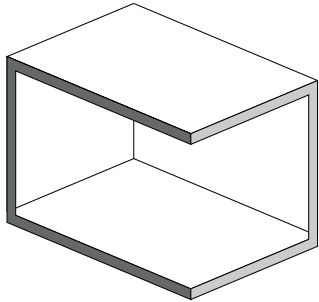

Within a partial enclosure that includes an overhead cove and no more than two walls. A common example is an outdoor gazebo.

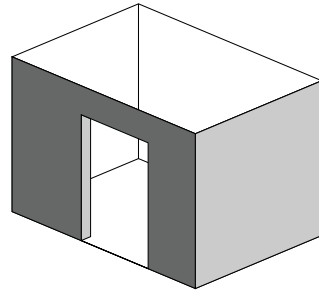

An enclosure with walls on all sides but at least one permanent opening at ground level

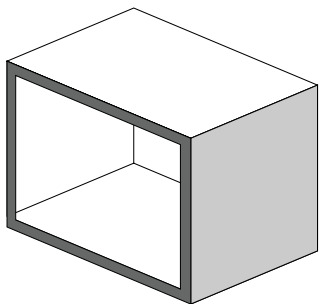

The appliance may be within a partial enclosure that includes an overhead cover and more than two walls, the following shall apply:

- At least 25% of the total wall area is completely open; and
- At least 30% of the remaining wall area is open and unrestricted.

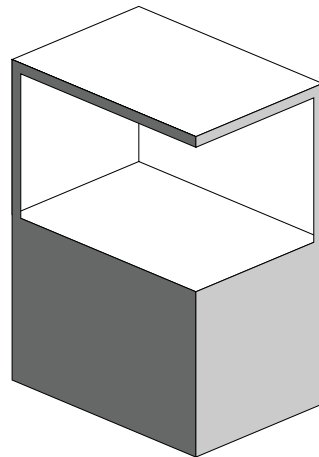

In the case of balconies, at least 20% of the total of the side, back and front wall areas shall be and remain open and unrestricted.

# SETTING UP YOUR OVEN

## INSTALLATION GUIDE

- Place a soft matt or rug down to protect the exterior of your pizza oven during the setup process.
- Remove all packaging elements.
- Place your pizza oven with the top facing downwards on to your matt/blanket. Whilst the pizza oven is standing on its top, open the three folding legs outwards.



- Stand the oven upright on its legs and remove the soft matt/blanket as this is no longer required. Insert the pizza stone into the appliance base as shown below and push it into the holder.



- Unscrew the black electronic ignition and insert a compatible battery (1 x AA) inside. Re-screw the cover back on. This will be used to ignite your appliance. Note: Regularly check your ignitor battery to ensure it has charge and replace when required. The AA Battery is not supplied with the appliance.
- Connect your gas hose to the valve, visible at the rear of your pizza oven (just below the control knob). Follow the Gas Connection steps outlined within this user manual.

- This appliance shall only be used in an above ground open-air situation with natural ventilation, without stagnant areas, where gas leakage and products of combustion are rapidly dispersed by wind and natural convection. This appliance must not be used indoors. Do not use your appliance in garages, porches, sheds or other enclosed areas. The appliance should not be placed close to or under any surfaces that will burn or are sensitive to heat. Do not block/obstruct the flow of air and combustion around the appliance housing while in use.
- A fairly protected location is desirable for pleasant and efficient cooking. Try to keep the pizza oven sheltered from strong winds as this will drastically reduce cooking efficiency. If this is unavoidable, position the appliance to face away from the direction of the wind. Keep the appliance level. Check frequently that the burner remains alight when used in conditions of strong wind. Make sure the minimum distances of the appliance to any wall or combustible surface are met, and that the supporting surface can withstand heat. When using the appliance, take care that the appliance feet are locked in their correct open position & the hose is not touching any hot surface.

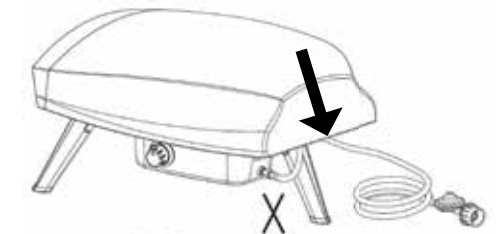

## GAS SAFETY

### ONLY USE THE HOSE ASSEMBLY TYPE 27 SPECIFIED BY THE MANUFACTURER ON THIS APPLIANCE. REPLACEMENT HOSE ASSEMBLIES MUST BE THOSE SPECIFIED BY THE MANUFACTURER.

This is a limitative configured appliance for LPG gas. Do not attempt to use other type gas supply unless the oven has been reconfigured for other gas use.

The installation of this appliance must conform to local codes.

Make sure that both gas cylinder and gas hose do not come in contact with any high temperature parts.

#### WARNING

Prior to use, check the oven and burner and venturi for blockages (e.g., food residue or insect nests - Wasps, Bees or Ants.) If an insect nest is found they can be dangerous and must be cleaned out thoroughly. Please refer to the cleaning and maintenance sections at the end of this chapter for guidance on how to do this.

Should the appliance go out for any reason, turn off the control knob and the cylinder gas valve. Wait 5 minutes before attempting to relight the appliance.

Some foods produce flammable fats and juices. Attend to an operating Pizza Oven at all times- it should never be left unattended. Damage caused by fat and grease fires is not covered by warranty. If a grease or fat fire should occur, immediately turn off burner knob and the gas cylinder valve until the fire is out. Remove all food from the appliance.

A leak test must be carried out prior to using the appliance for the first time and whenever the gas cylinder is refilled or whenever the gas hose and regulator have been disconnected from the gas cylinder or appliance. Apply soapy water to the entire hose assembly type 27, including the gas bottle's valve and regulator, using a spray bottle or sponge. Pressurise the system without turning on your Pizza Oven (i.e. slowly open the gas supply on your gas bottle). If you see bubbles or smell rotten eggs, you have a leak.

Dishwashing liquid/soap is formulated to make lots of bubbles and ideal for mixing with water to make your soapy liquid for this leak test.

Please take a moment to review all of the safety requirements before operating the appliance when using gas.

- Do not disconnect any gas fittings while the appliance is operating
- Check all gas hose lines and connections for cuts, cracks and other damage. Gas cylinders must not be stored in enclosed areas
- Keep the fuel supply hose away from heated surfaces or direct sunlight. Do not use any additional flammable substance whilst operating with gas
- Do not touch! The Pizza Oven can get extremely hot when in operation. Be sure to wear protective gloves
- Keep the cylinder outdoors in it's upright position
- Do not connect multiple gas canisters to Pizza Oven or store a spare within the same vicinity
- Only use a regulator certified to AS 4621 and a hose assembly type 27 certified to AS/NZS 1869, between the gas cylinder and the pizza oven
- Do not position the gas canister under the oven. Never use a naked flame to check for gas leaks. Do not use natural gas! It can damage the oven
- Maximum length of hose cannot exceed 1.5m
- National requirements state how often to replace the hose
- Never fill the cylinder beyond 80 percent full
- Make sure the flexible tube is not twisting when the appliance is in operation.

#### CONNECTING TO GAS

Step 1: Check that the gas you have is Propane LPG.

#### IMPORTANT!

The gas cylinder used must have a safety collar to protect the valve assembly. Do not use a cylinder that is rusty, dented, has a damaged valve or has past any expiry dates.

Note: Only certified gas regulators to AS 4621 and certified hose assemblies to AS/NZS 1869, may be used.

Note: The length of the gas supply hose must not exceed 1.5m.

#### IMPORTANT!

Keep the gas hose away from hot surfaces and protect from dripping grease. Avoid unnecessary twisting of hose. Visually inspect the hose prior to each use for cracks, excessive wear or other damage. Replace the hose if necessary. It is recommended that you replace the hose every 5 years.

#### WARNING

Do not connect the regulator to the cylinder first!

#### WARNING

If at any point you smell gas:

- Shut off the gas at the cylinder
- Rotate the control knob on your Pizza oven to the off position (clockwise), which should extinguish any open flames
- If odour continues, move away from the pizza oven and gas supply, then contact your local fire brigade for further assistance.

Step 2: Connect the regulator to the gas cylinder, following the instructions for your regulator accordingly. Don't force the regulator as this could damage the gas cylinder or regulator fitting.

#### CONNECTING THE LIQUID PROPANE CYLINDER

To connect the Liquid Propane gas supply cylinder: The cylinder valve should be in the "OFF" position. If not, turn the valve clockwise until it stops. Make sure the cylinder valve has the proper connections per LCC27. Make sure the burner valve is in the "OFF" position. Inspect the valve connections, port and regulator assembly to the valve, use your hand to tighten the nut clockwise until it stops. Use of a wrench could damage the quick coupling nut and result in a hazardous situation, open the cylinder valve fully by turning the valve counter-clockwise. Before lighting the oven, use a soap and water solution to check all the connections for leaks. If a leak is found, turn the cylinder valve "OFF" and do not use the oven until a local Liquid Propane dealer can make repairs.

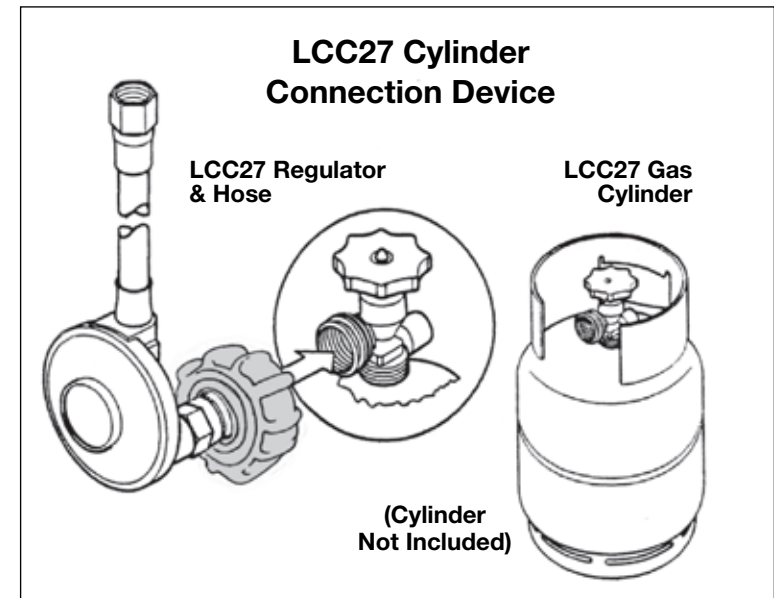



## WARNING!

### DO NOT USE AN ADAPTOR AT THE CYLINDER CONNECTION

1. Do not store a spare LP gas cylinder under or near this appliance.
2. Never fill the cylinder beyond 80 percent full
3. If the information in item 1&2 is not followed exactly, a fire causing death or serious injury may occur.

**CAUTION:** Place dust cap on cylinder valve outlet whenever the cylinder is not in use. Only install the type of dust cap on the cylinder valve outlet that is provided with the cylinder valve. Other types of caps or plugs may result in leakage of propane.

### DISCONNECTING THE GAS

After cooking, turn off the gas from the gas cylinder before turning off your Pizza Oven. This will allow any gas left within the burner and/or hose assembly type 27 to be used up safely.

Once the flames are fully extinguished within the pizza oven (up to 2 mins), you can rotate the Pizza Oven control knob to the off position (clockwise).

It is now safe to disconnect the Regulator and hose assembly type 27 from your gas cylinder.

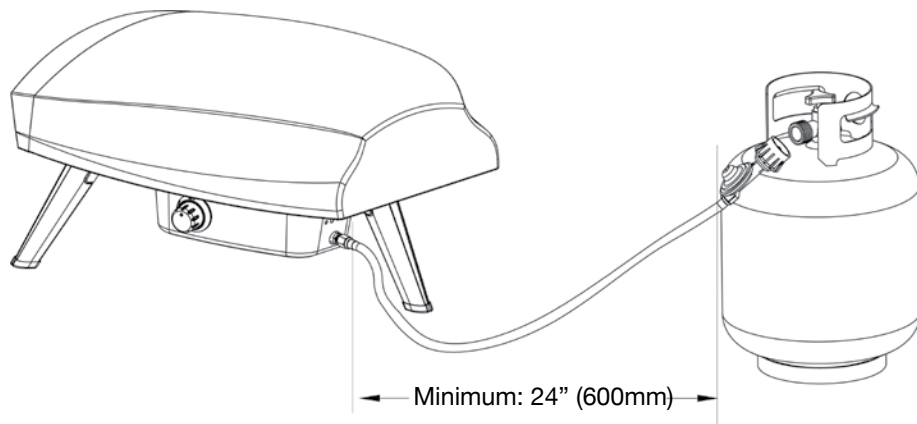

Only use the appliance with gas cylinder that does not exceed 600mm in height and 300mm in diameter.

**SafeLok**

This appliance has been supplied with the new safer gas cylinder connection Safe Lok LCC27 Type 27 regulator and hose connection. This connection will only connect to a 4kg or 9kg gas cylinder with an LCC27 Type 27 cylinder valve. This connection will NOT connect (screw) to the old type 21 POL gas cylinder valve.

## FIRST USE

To burn off any residual manufacturing oils, it's important to run your Pizza Oven for a period of time without cooking.

1. Turn on the gas supply at your gas cylinder.
2. Press and hold the control knob down and turn to the Max heating position for at least 15 seconds. You will hear the ignitor 'clicking' and the burner should alight within your appliance.
3. Turn the control knob down to the Low setting and run your appliance on this setting for 30 minutes.
4. Use your control knob to increase the power to approximately ¾ high power level and run for a further 15-20 minutes.

## REGULAR USE

### LIGHTING INSTRUCTIONS:

1. BEFORE IGNITING THE APPLIANCE, OPEN THE COVER OF BATTERY AND PLACE AN AA BATTERY INSIDE IT, THEN TIGHTEN IT (REMEMBER TO REPLACE THE BATTERY WHEN NO SPARK COMES OUT).
2. Ensure hose and connections are leak tight.
3. Push in control knob and slowly turn anticlockwise to MAX holding down the knob for 15 seconds to ensure the burner is alight. Keep face away from opening.
4. If burner does not light turn knob to "OFF" and wait 3 minutes for gas to dispel before repeating step 3 Follow match lighting instructions if the burner can't be lit after repeating 3-4 times.

### MATCH LIGHTING PROCESS

If for some reason, the ignitor fails to produce a spark at the electrode, the appliance can be lit by a long barbecue match using the match holder supplied. Push and turn the control knob while inserting the lit match through the front of the oven.

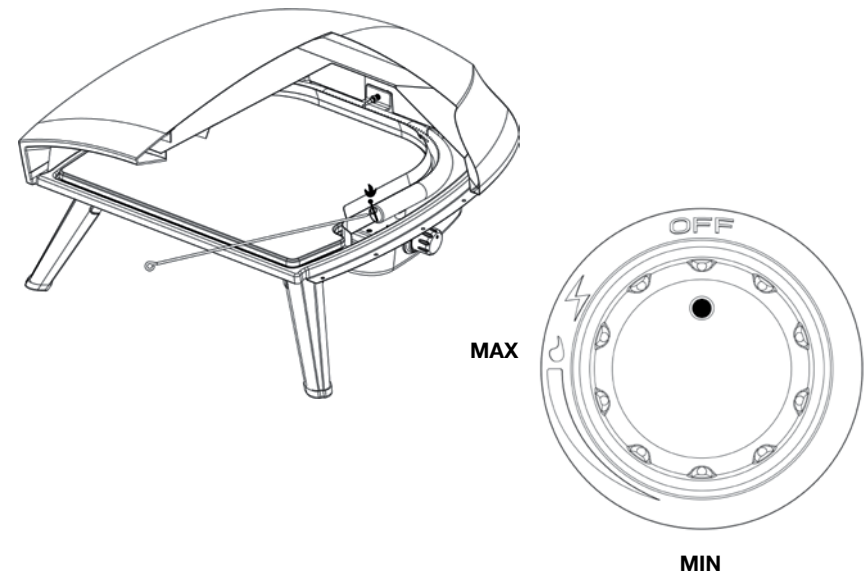

## USING YOUR PIZZA OVEN

There is a lot of variability when it comes to cooking pizzas, including the type of dough, thickness, types of toppings, etc which will all vary your cooking time and optimum heat settings. It may take some trial and error to begin with! Our recommended setting is as follows.









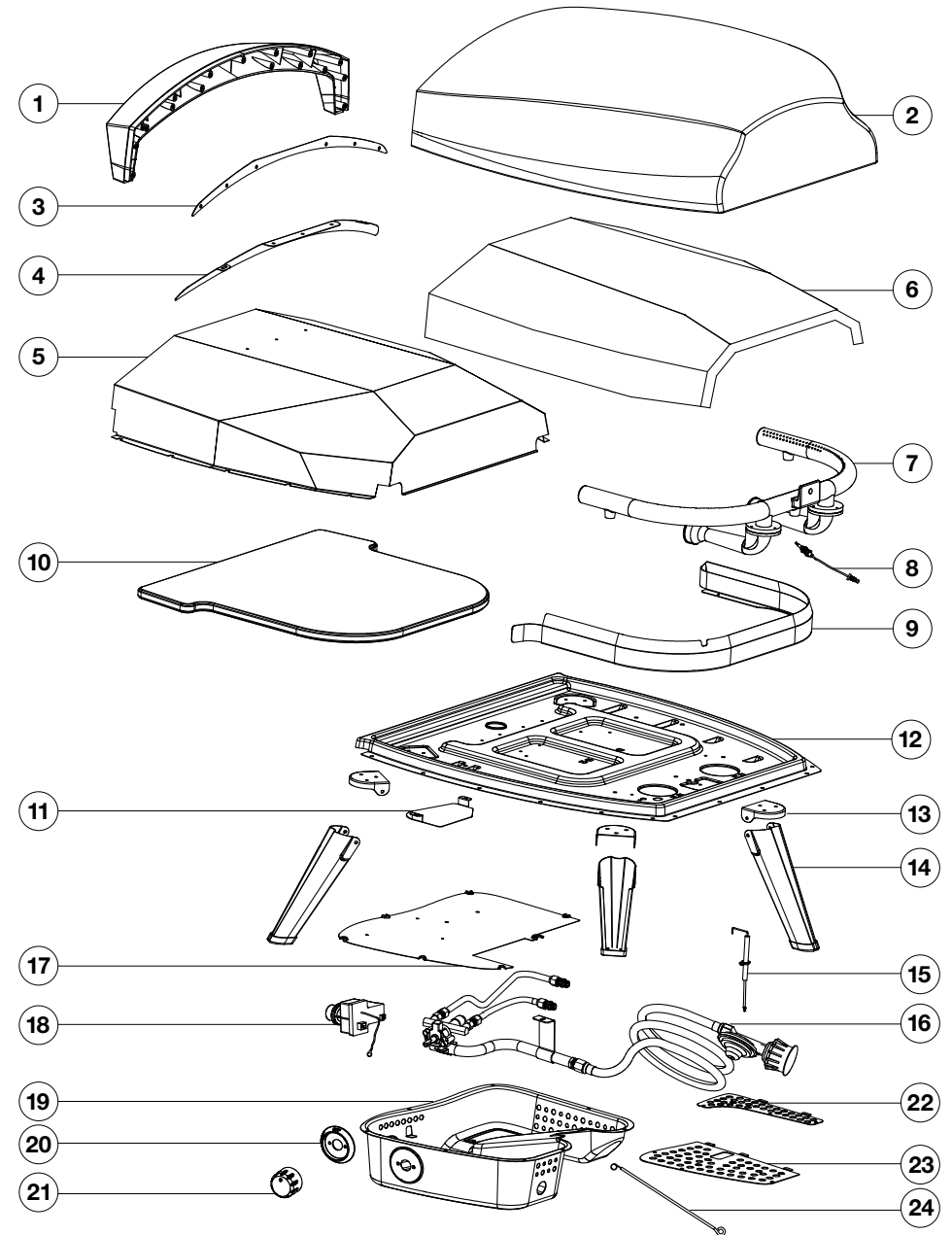

1. Heat up your pizza oven on high for at least 10 minutes before you are wanting to cook. This will allow the pizza stone to achieve a suitable temperature for cooking your pizzas.
2. Using your pizza peel (paddle), slide your first pizza into the oven. Keeping towards the front.
3. Halfway through cooking (typically 45 seconds), use your pizza paddle to remove your pizza. Rotate the base on your pizza paddle and re-insert into the oven. This will help to ensure your pizza cooks evenly.
4. Use your pizza peel to remove your cooked pizza from the oven. Typically, 90 seconds on HIGH.

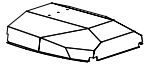
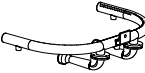
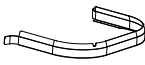









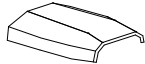

### TIPS:

If your pizza is burning, turn down your pizza oven to between 3/4 to 1/2 power level. Dusting your pizza base with some flour will help ensure it slides from your pizza peel without sticking. Brushing your pizza paddle with some flour can also assist.

## OVEN EXPLODED DIAGRAM



NO.	DESCRIPTION	FIGURE	QTY
1	Decorative plate		1
3	Decorative plate seals		1
5	Inner lining plate		1
7	Burner assembly		1
9	Pizza stone baffle		1
11	Pulse diaphragm		1
13	Foot base		3
15	Ignition needle		1
17	Valve heat shield		1
19	Control panel		1
21	Knob		1
23	Control panel cover		1

NO.	DESCRIPTION	FIGURE	QTY
2	Shell plate assembly		1
4	Tail flame baffle		1
6	Insulating cotton		1
8	Thermocouple		1
10	Pizza stone		1
12	Bottom plate		1
14	Feet		3
16	Gas inlet assembly		1
18	Pulse igniter		1
20	Knob bezel		1
22	Test cover plate		1
24	Ignition stick		1

## CLEANING & MAINTENANCE

### Enamel Cleaning

**DO NOT USE AN ACID DETERGENT AND/ OR ANTI-RUST CLEANER ON THE CONTROL PANEL. SUCH CLEANING PRODUCT MAY DAMAGE THE APPLIANCE OR REMOVE THE CONTROL PANEL PRINTING.**

### Cooking Area Cleaning (including pizza stone)

The easiest way to clean the oven is to clean immediately after turning off the flame and once your cooking has been completed.

### WARNING

Keep in mind that your appliance will be hot after cooking! Always wear long safety gloves designed for heat (such as barbecue mitts) to protect your hands and arms from any heat, steam and hot parts.

Dip a wire bristle barbecue brush in water with a mild detergent and scrub the pizza stone. Dip the brush frequently in fresh water. Steam, created as water contacts the hot oven, assists the cleaning process by softening any food particles. The food particles will lift from the stone. It is completely normal for the stone to remain discoloured though and won't affect the product or future cooking.

**Important!** Never immerse a hot part in water.

Alternatively, allow your appliance to completely cool and remove the pizza stone for cleaning. Again use a mild detergent with some warm water and a barbecue brush to scrub the stone.

### General Cleaning of Painted Surface

When cleaning your pizza oven use a mild dish soap combined with warm water and a microfiber cloth to clean the surface. Then rinse your pizza oven with clean water.

Note: Never use steel wool or any hard cleaning pad on any painted and stainless steel surface, as it can cause surface damage.

If not in use, turn off the gas from the source. After cleaning and when it is dry, spray some canola oil over the whole pizza oven surface and wipe off the excess with microfiber cloth to enhance the surface protection. Then cover the pizza oven with a cover and store it in a dry place.

### Appliance Burner Cleaning

1. Be sure the gas cylinder valve is firmly in the off position and that the appliance control knob is also in the Off position. Make sure the appliance is completely cool.
2. Clean the exterior of the burner with a wire brush. Clear stubborn scale with a metal scraper. Clear any clogged ports with a straightened paper clip. Never use a wooden toothpick as it may break off and clog the port.
3. Please note: if insects or other obstructions are blocking the flow of gas through the burner, you will need to call our customer service line.

Please contact our after-sales service team for any replacement part requirements. Only engage a qualified technician for any replacement or repair works.

## TROUBLESHOOTING

If you think you've got a problem with your Pizza Oven, follow the following troubleshooting steps to try and resolve it. If you have any questions, contact after-sales service.

It is recommended to replace the gas hose every 5 years. Replacement hose assemblies and regulators can be purchased from your nearest hardware store.

Issue:	Potential Cause:	Solutions:
Weak flame	<ul style="list-style-type: none"> <li>• Empty or low gas cylinder</li> <li>• Operation at high altitude</li> <li>• Cold gas cylinder</li> </ul>	<ul style="list-style-type: none"> <li>• Try a different gas cylinder</li> <li>• Check the gas regulator and hose assembly type 27</li> </ul>
Noisy burner	<ul style="list-style-type: none"> <li>• Debris is blocking the burner outlets</li> <li>• Debris in venturi</li> </ul>	<ul style="list-style-type: none"> <li>• Clean the burner: read the cleaning &amp; maintenance section of this user manual for steps</li> </ul>
Slow heat up	<ul style="list-style-type: none"> <li>• Empty gas cylinder</li> <li>• Cold weather</li> <li>• Windy conditions</li> </ul>	<ul style="list-style-type: none"> <li>• Try a different gas cylinder</li> <li>• Check the gas regulator and hose assembly type 27 to ensure its not damaged or kinked</li> <li>• Sheltered location</li> </ul>

## TECHNICAL SPECIFICATION

Model	PO3106-16	
Gas type	Propane	
Burner injector size	1.1mm	
Burner gas pressure	2.75 KPA	
Total gas consumption	28.8 MJ/h	
<p>Warning: For storage and cylinder exchange, disconnect hose at the cylinder only. DO NOT disconnect hose from the appliance. Minimum clearances from pizza oven to combustible surfaces. Sides: 1.5m Back: 1.5m Above: 1.5m</p>		

**For any queries or assistance call**



**Customer Service** (Australia Only)

**1300 174 876**

Hours of operation:  
Monday to Friday 8am - 5pm EST

**Do not return to place of purchase.**

Keep your purchase receipt, this will be required to make any claims under the 1 year warranty.

**Gasmate**